

KOMPLEKS PENYIARAN NEGERI PERLIS
BAHAGIAN REKABENTUK FASILITI BANGUNAN AM 3
CAWANGAN ARKITEK IP JKR MALAYSIA 2020

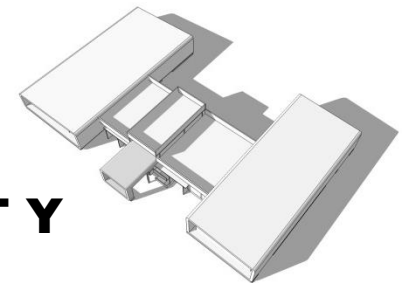



CONNECTIVITY





LOT 20 005
10.12 ACRES
40967.7 m²

50%
IS ALLOCATED
FOR DEVELOPMENT;
4 X FOOTBALL FIELD

SITE

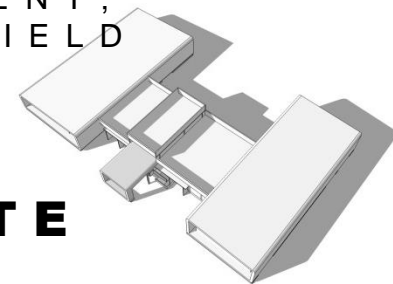



“an organization’s
second-largest
expense”

REVISITING
OFFICE
SPACE STANDARD;
HAWORTH

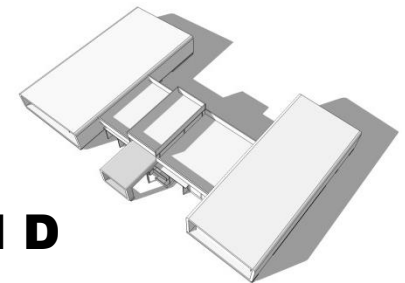

TIME & TREND

STRUCTURE & SKIN

Monocoque Construction

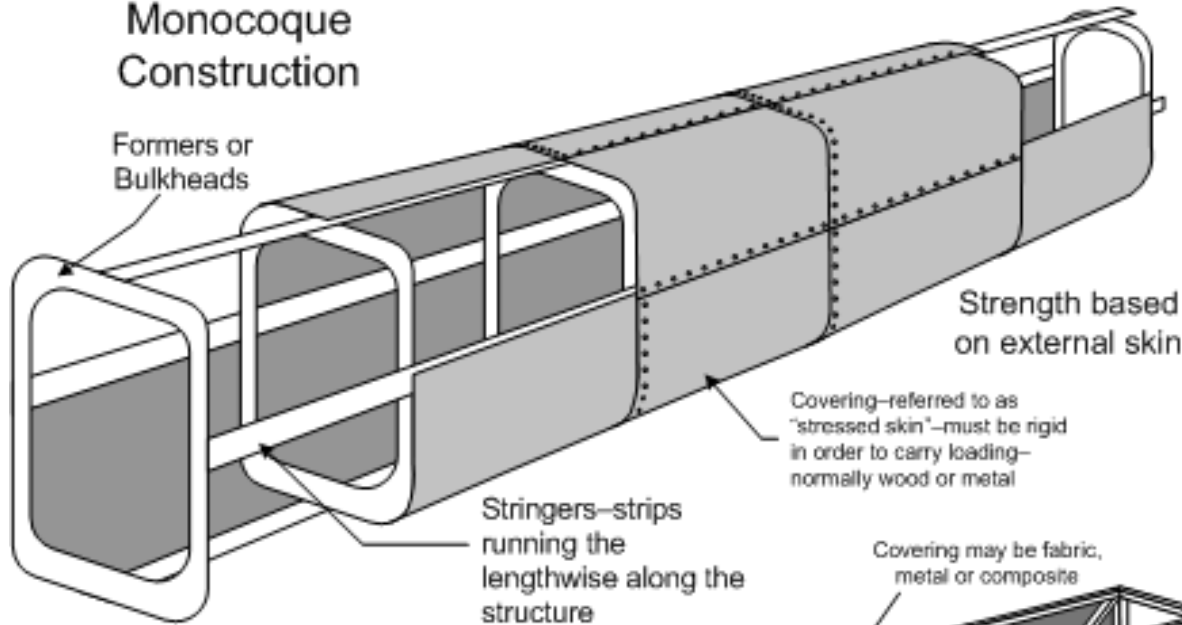

Truss Construction

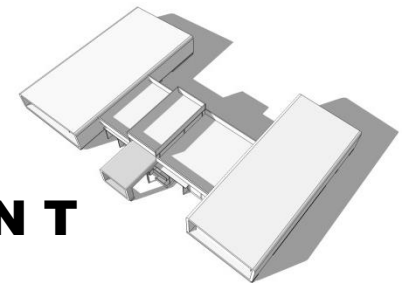
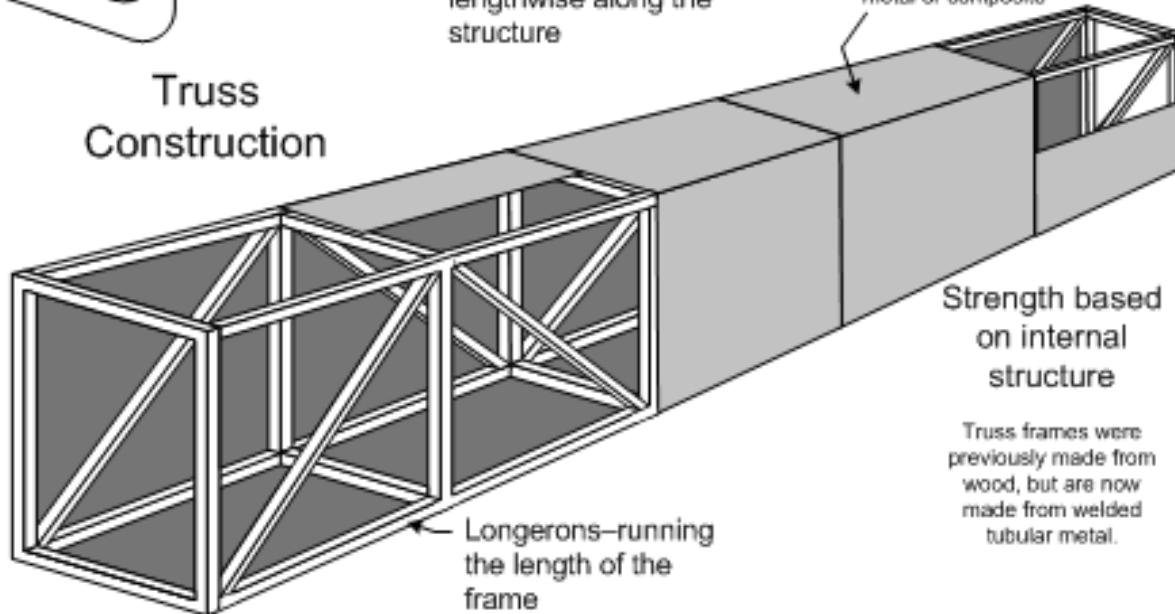

STARTING POINT

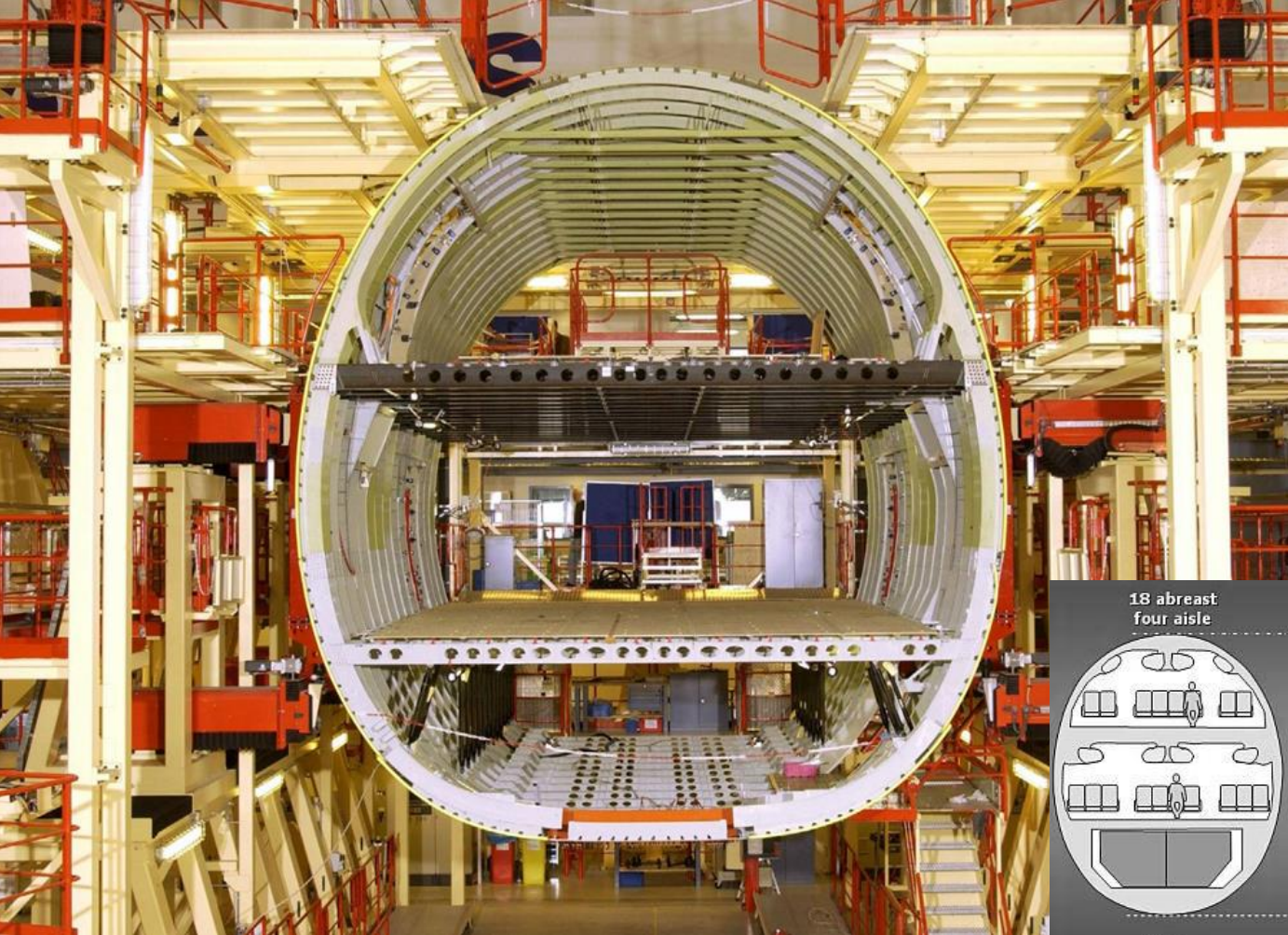

AIRBUS 380
 550 people
 534km length
 of wiring

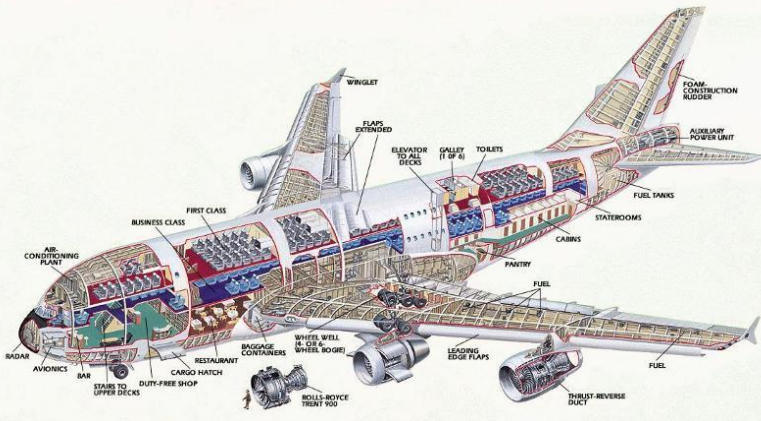
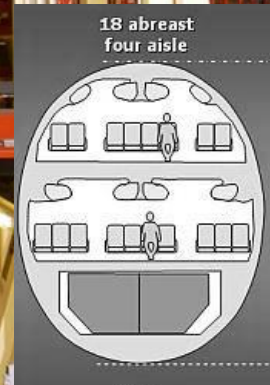

- * H 8 4 0 0
- * W 7 1 5 0
- * L 7 3 0 0 0

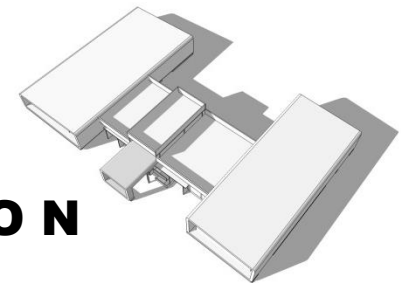

FORMATION

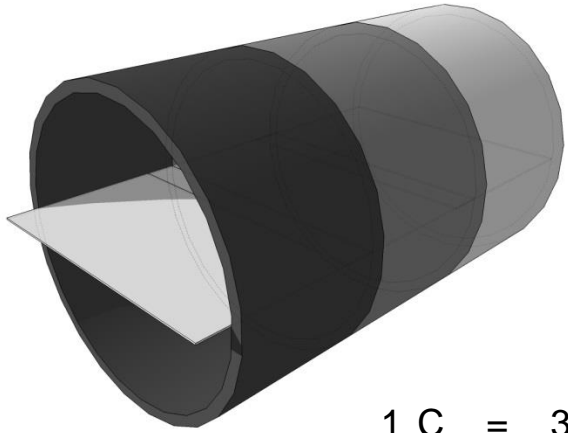

1 C = 3 D
LINEAR + SEGMENTED

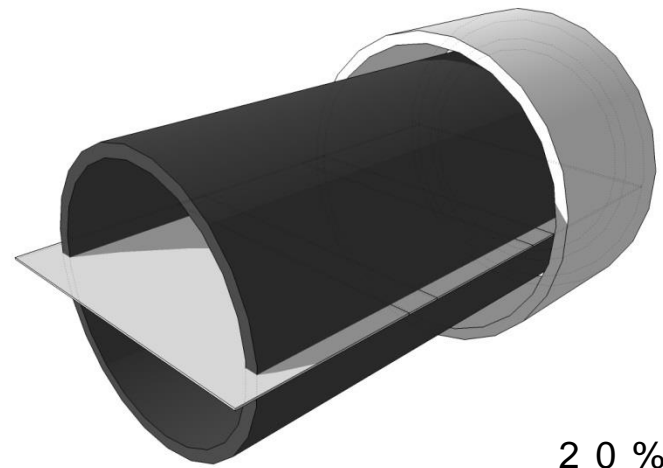

20 %
SURFACE REDUCTION

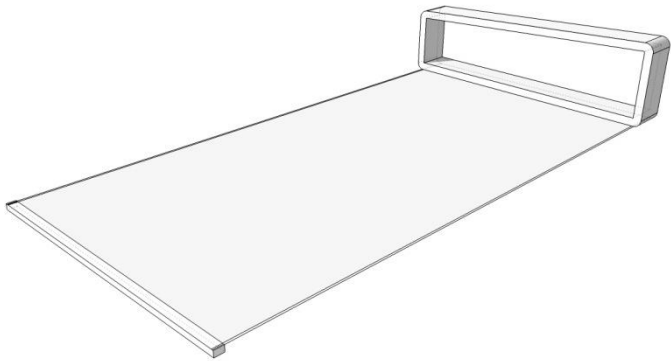

FLAT LAY

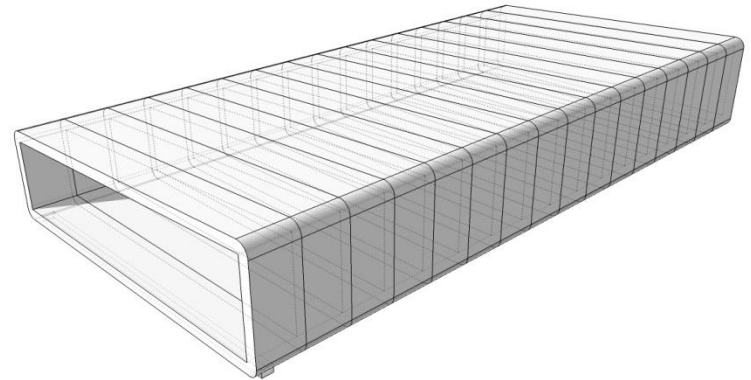

SPACE UTILIZATION

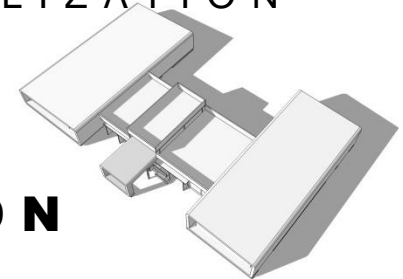

FORM FORMULATION

FUNDAMENTAL
FORM

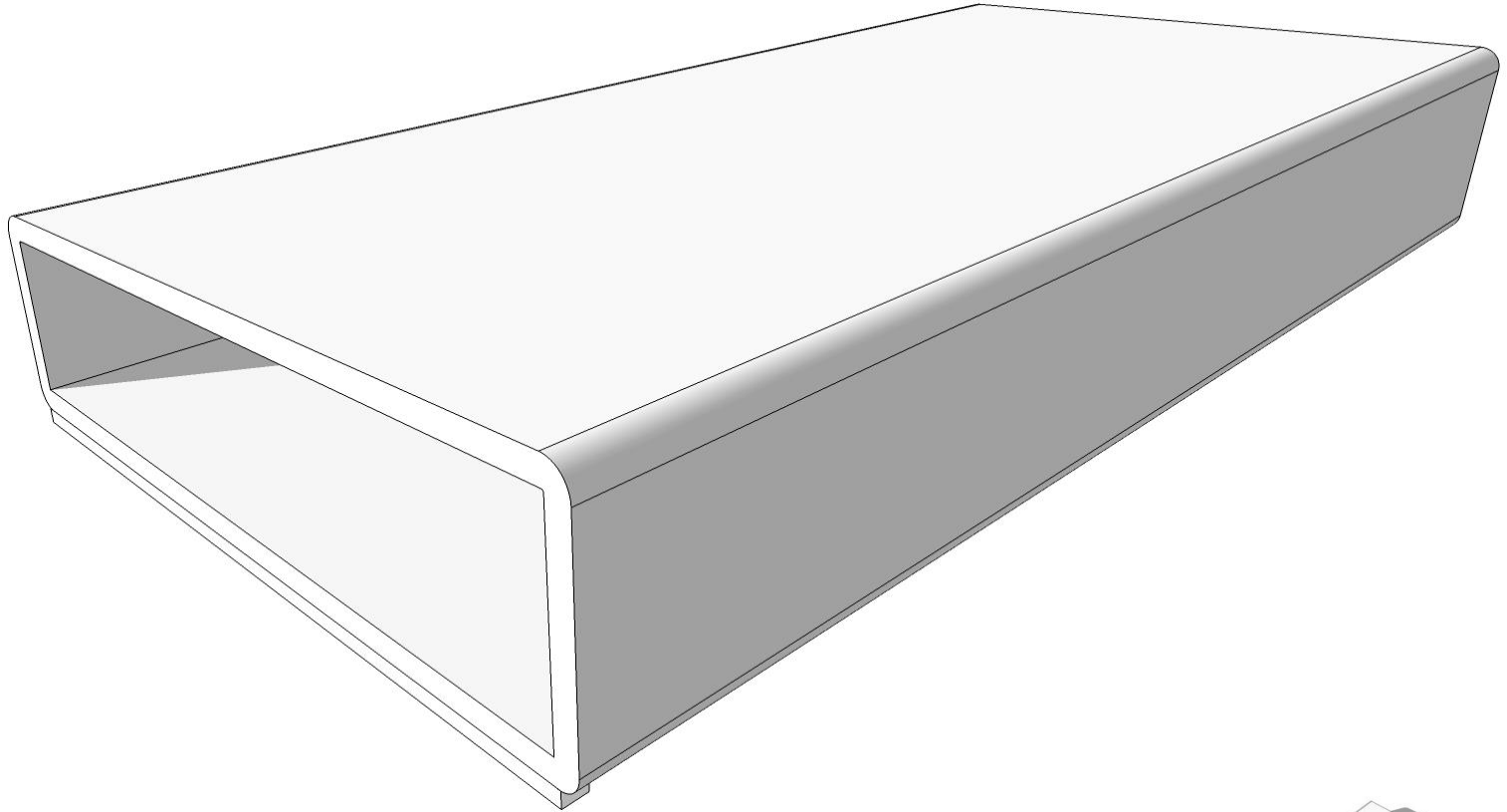

VOID AND SOLID

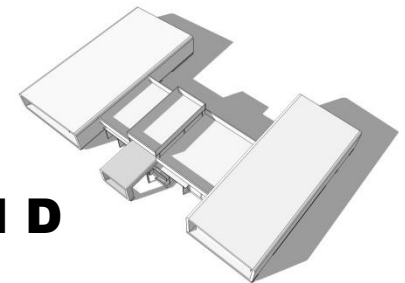

FUNDAMENTAL
FORM

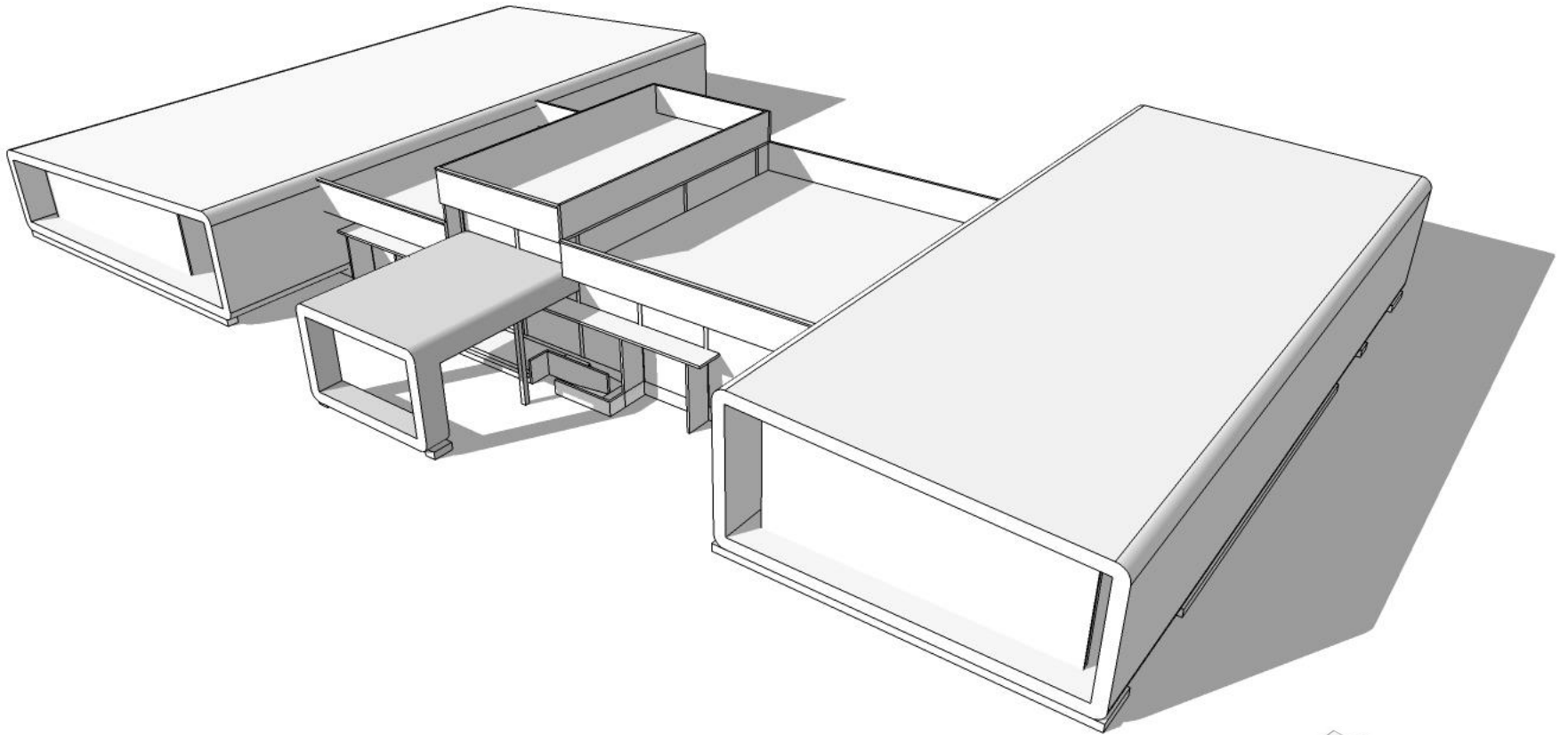

FORMS CONNECTIVITY

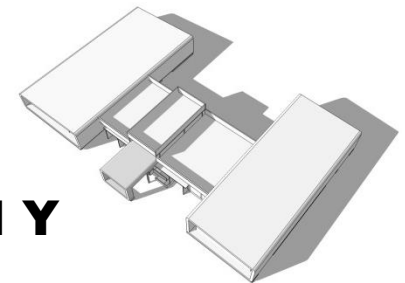

FUNDAMENTAL
FORM

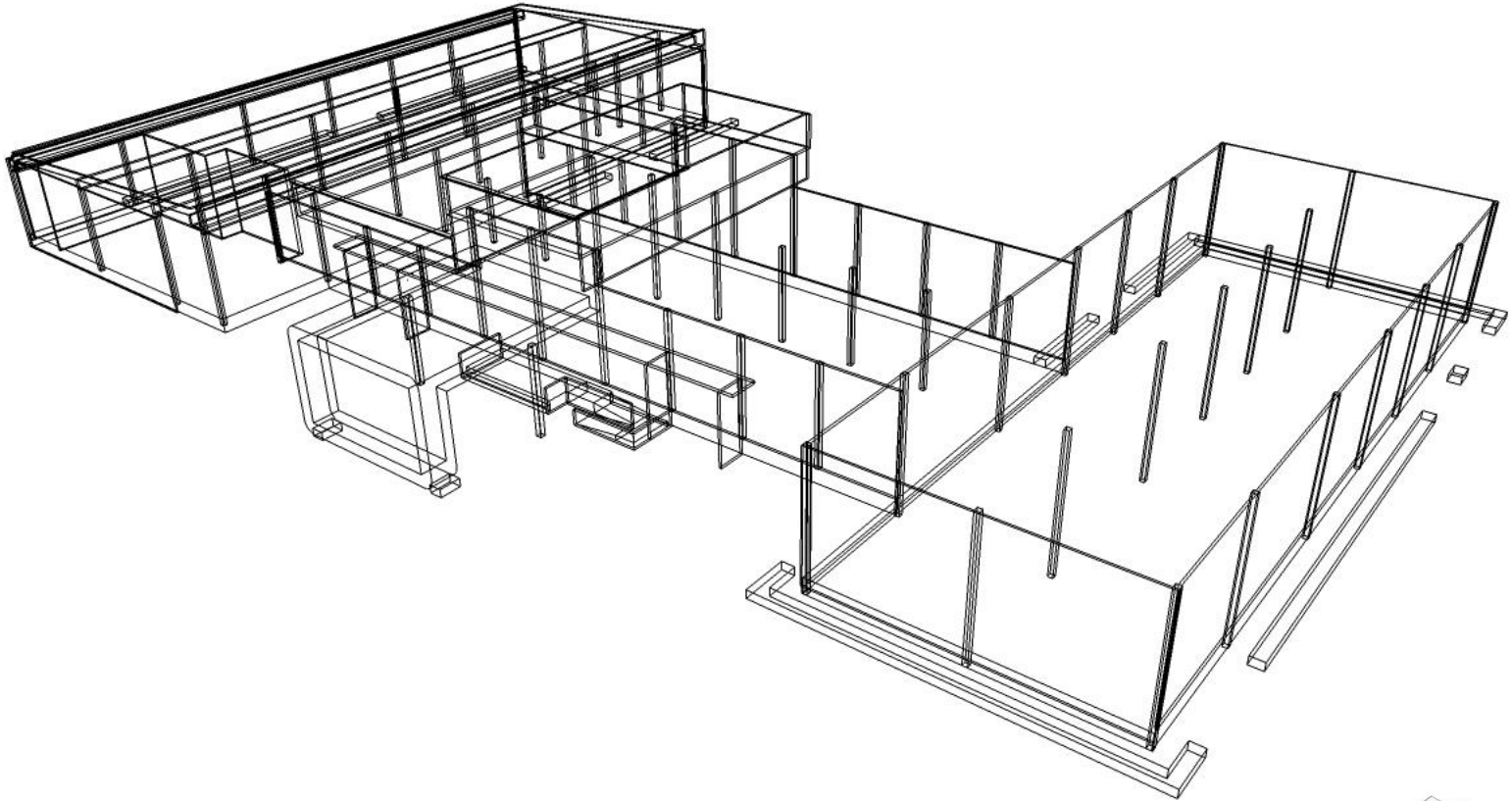

STRUCTURE CONNECTIVITY

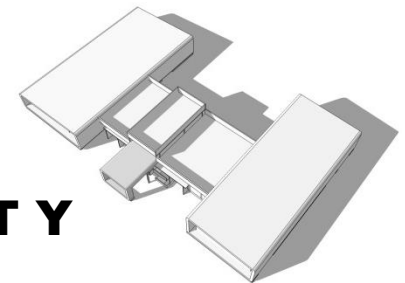

FUNDAMENTAL
FORM

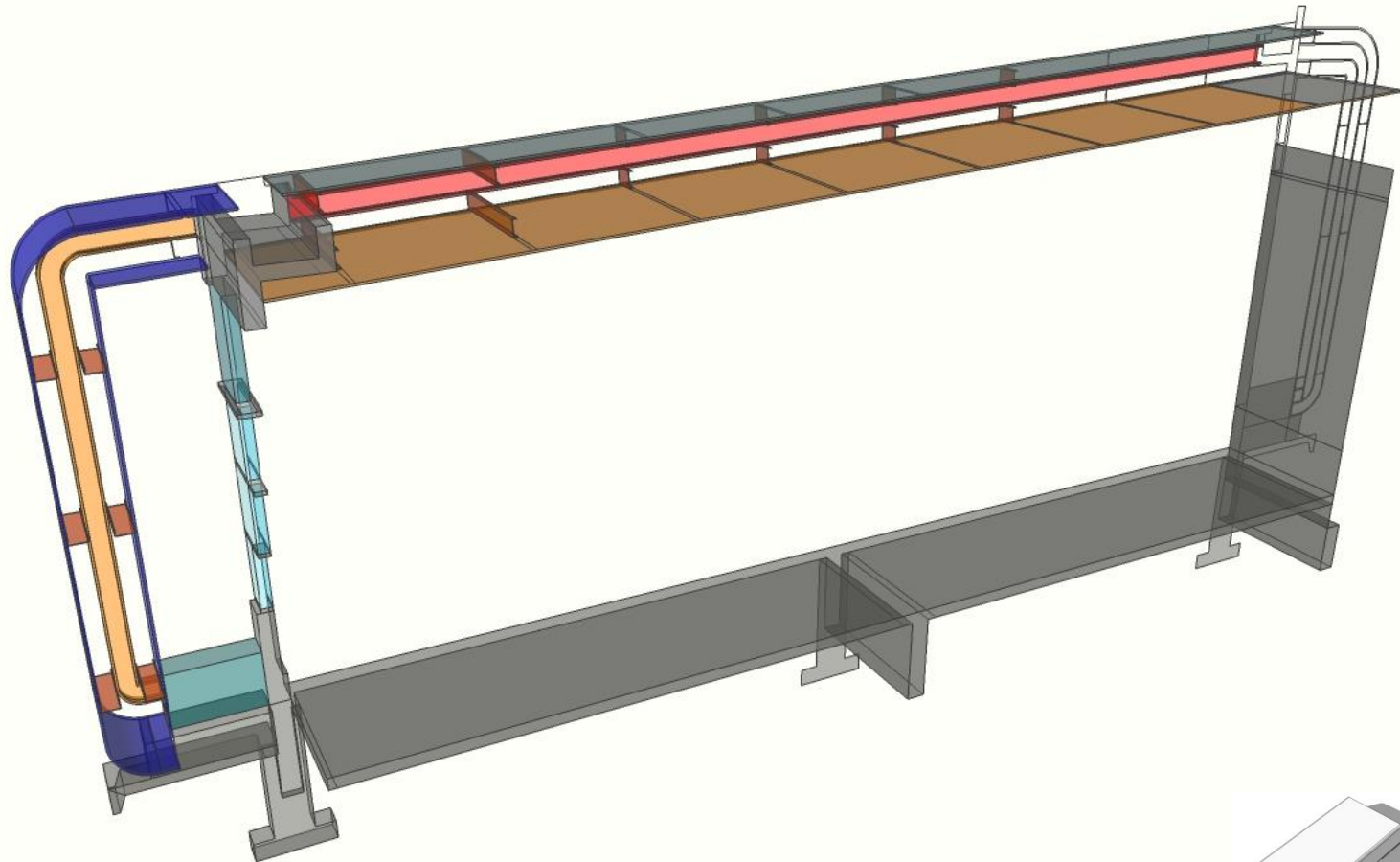

ENGINEERING INTERVENTION

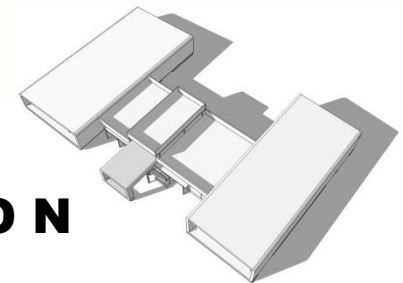



PLAN

FUNCTIONS CONNECTIVITY

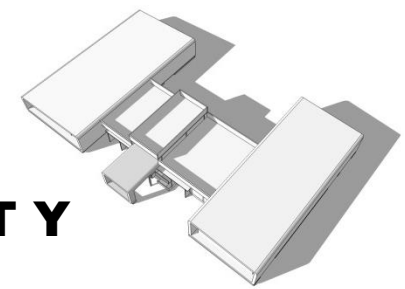



FRONT

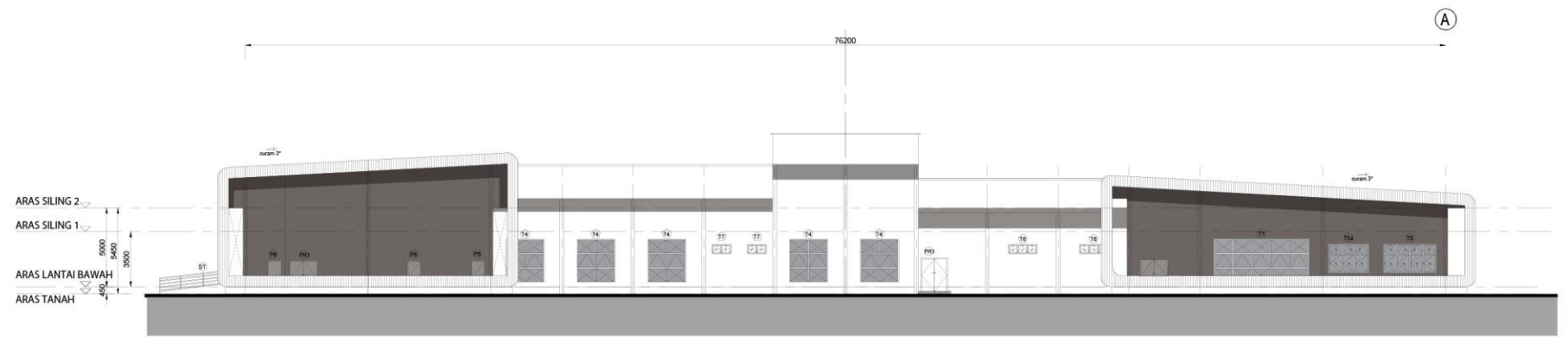

BACK

ESTABLISHMENT

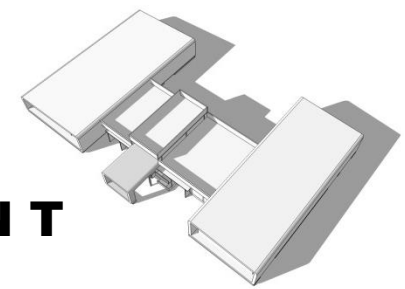



LEFT

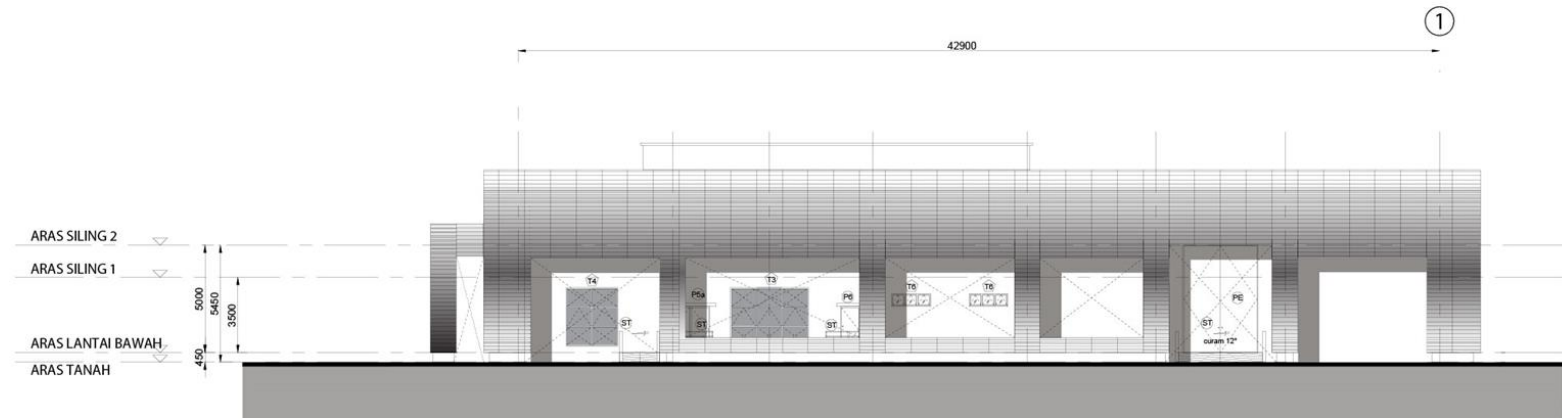

RIGHT

ESTABLISHMENT

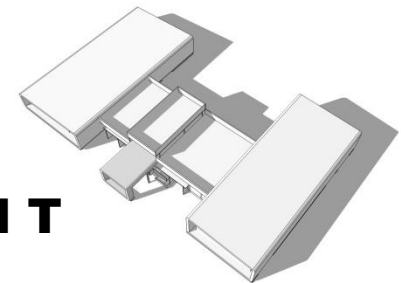



ESTABLISHMENT

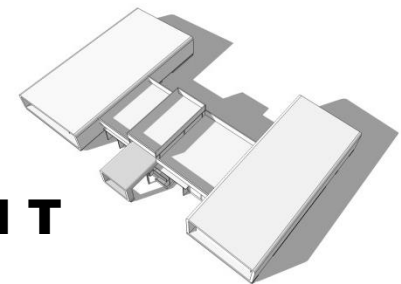

PHOTOVOLTAICS

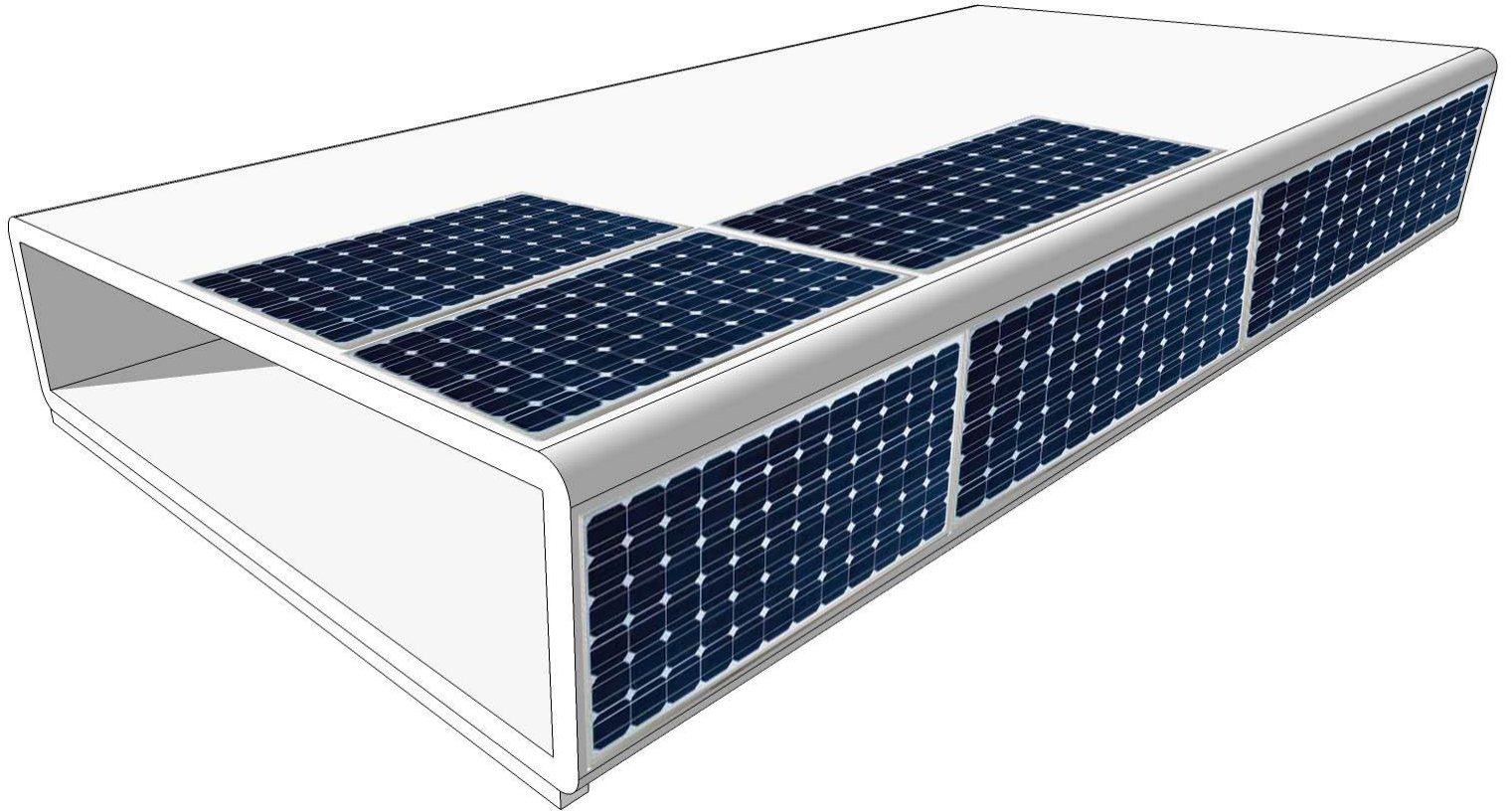

FUTURE PROGRAMS

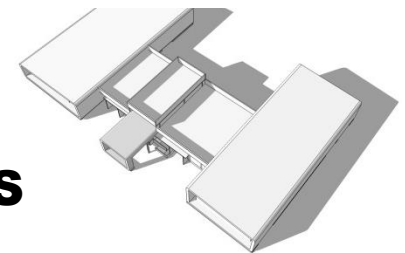

GREEN FACADE

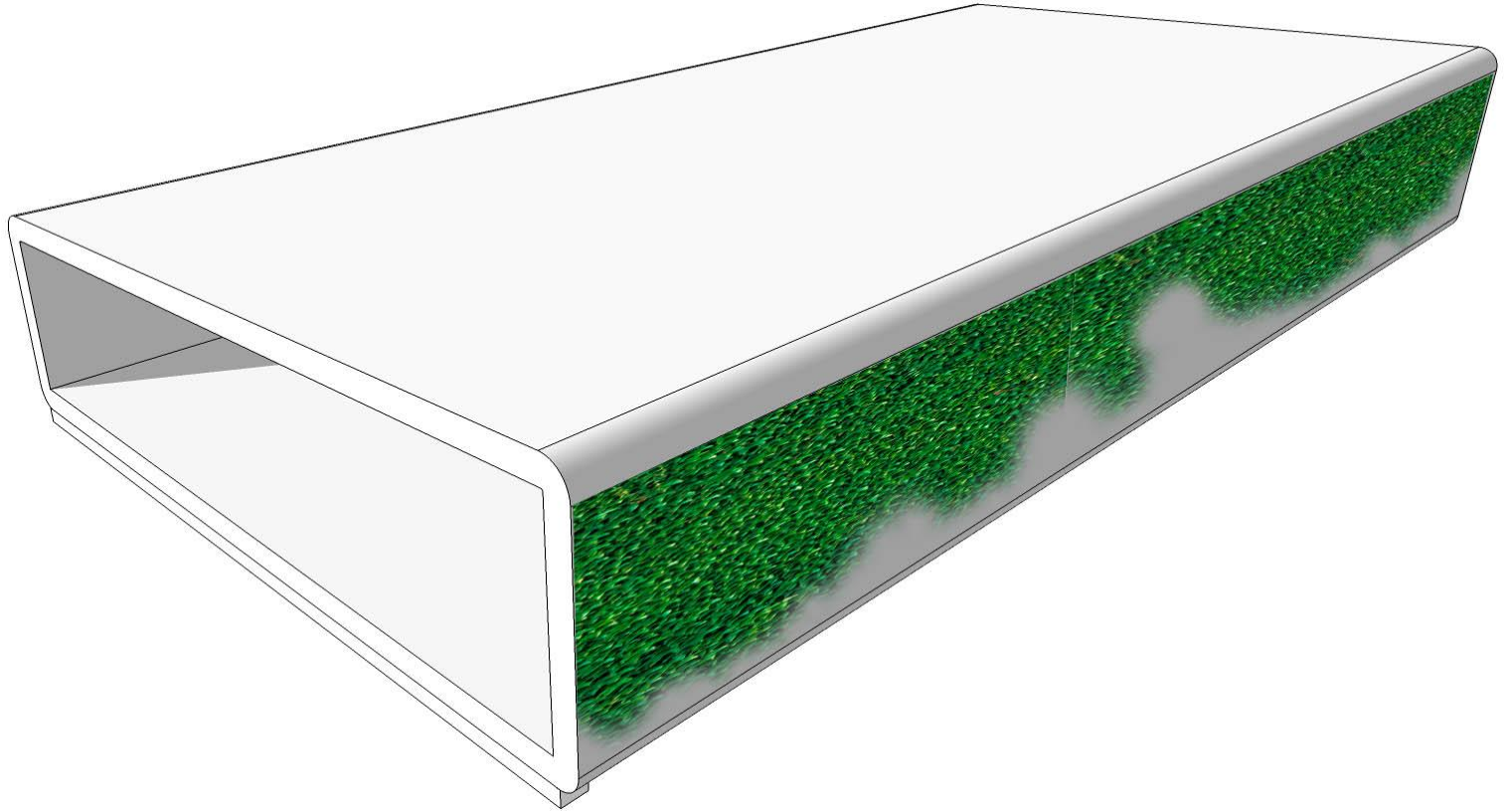

FUTURE PROGRAMS

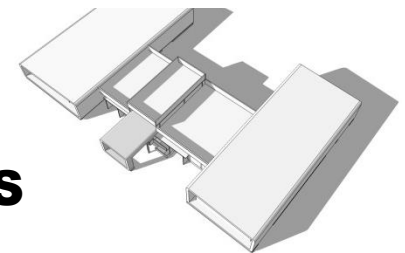



ACTUAL PROGRAMS

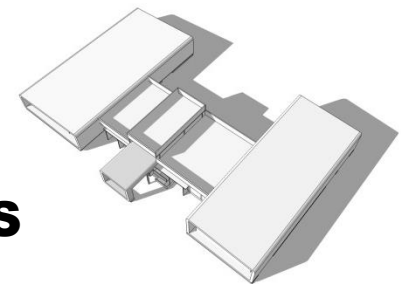

FRONT FAÇADE & THE VIOLIN



ACTUAL PROGRAMS

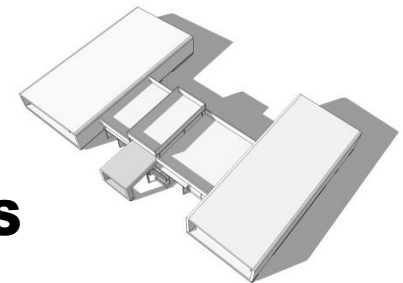

DETAILING & THE MONOCOQUE



ACTUAL PROGRAMS

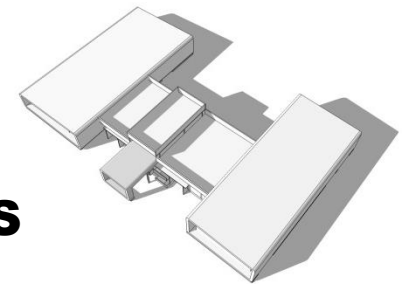

AMBIENCE



ACTUAL PROGRAMS

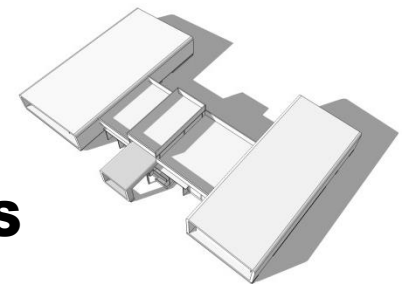

AMBIENCE



ACTUAL PROGRAMS

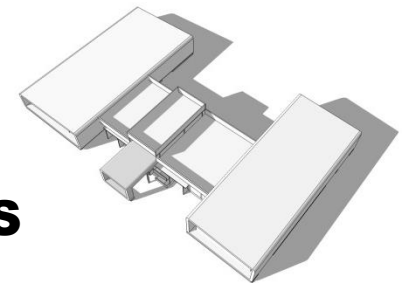

INTERIOR AND EXTERIOR

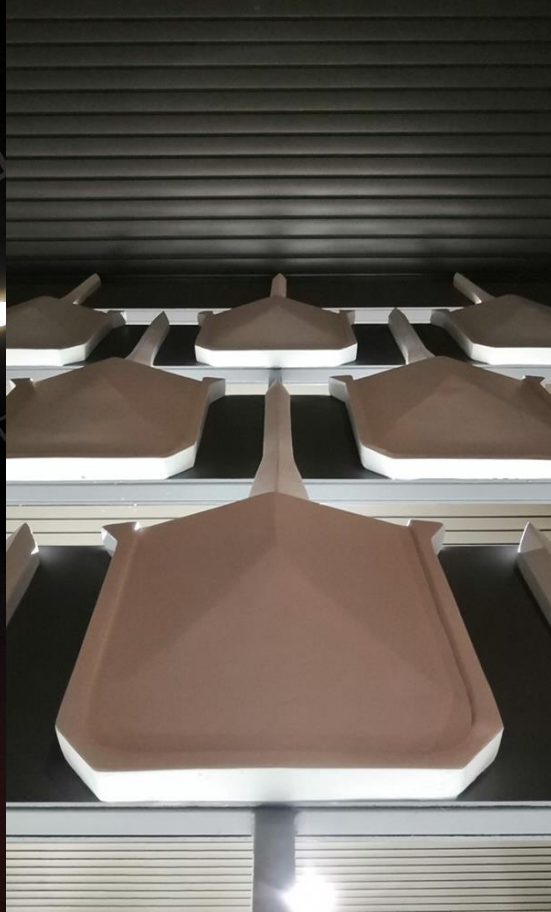

ACTUAL PROGRAMS

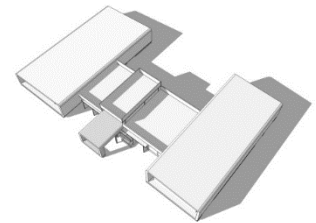

THANK YOU

